

**MIOL-A  
MIOL-AB  
MIOL-AC**

**MEDIUM  
INTENSITY**



Medium intensity obstruction light multiled type, compliance to ICAO type A and FAA L-865, FAA DUAL L-864/L-865, single or twin, day and night.

- Based on led technology
- Flashing white light (20-60 fpm) in day and night mode
- Flashing red light (20-60 fpm) in night mode (Type MIOL-AB)
- Steady burning red light in night mode (Type MIOL-AC)
- Long life time >10+ years expectancy
- Stabilized light output

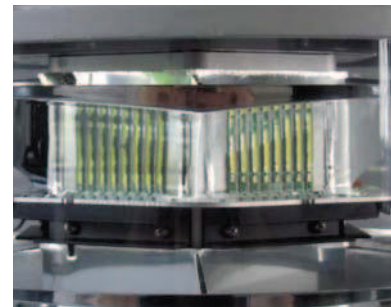
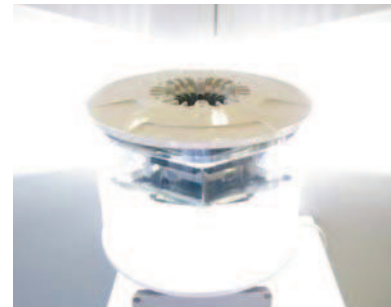
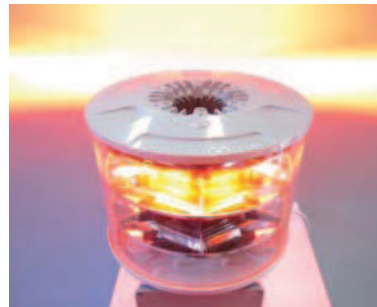

**Order Code**

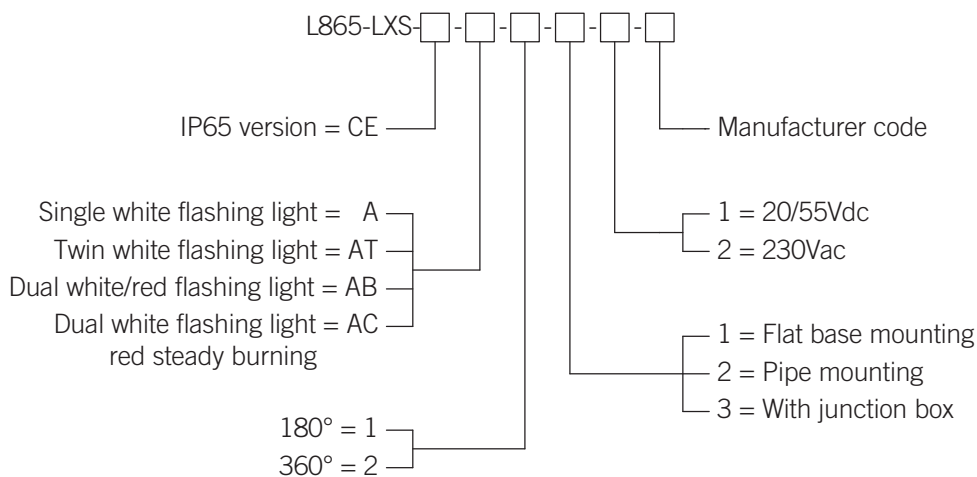

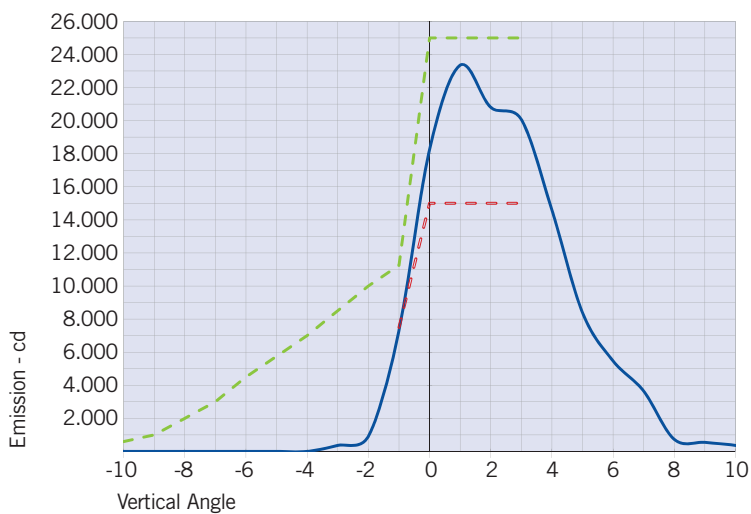

- L865-LXS-A average emission level at 90°C ambient temperature
- ICAO ANNEX 14 medium intensity type A Minimum Required Intensity
- ICAO ANNEX 14 medium intensity type A Maximum Required Intensity

BEACON FRONT VIEW

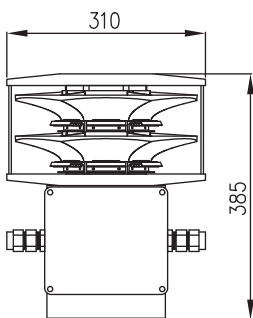

BEACON SIDE VIEW

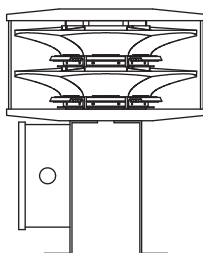

FIXING DETAILS

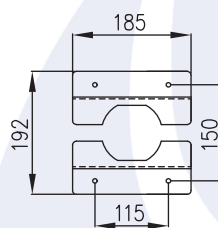

DUAL BEACON FRONT VIEW

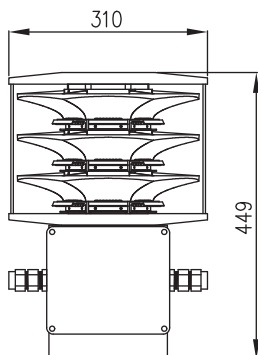

DUAL BEACON SIDE VIEW

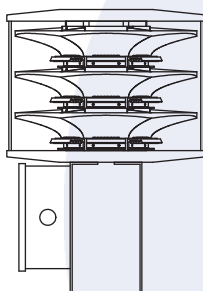

FIXING DETAILS

